

An extra-small footprint to easily fit into control cabinets

EDS-2000/G2000-EL Series
Industrial Unmanaged Ethernet Switches

- 5 or 8 ports with full Gigabit and fiber options
- Supports 12/24/48 VDC input
- Microsecond-level latency
- High EMC resistance
- -40 to 75°C operating temperature (-T models)

Your Trusted Partner in Automation

Moxa is a leading provider of edge connectivity, industrial computing, and network infrastructure solutions for enabling connectivity for the Industrial Internet of Things (IIoT). With 35 years of industry experience, Moxa has connected more than 94 million devices worldwide and has a distribution and service network that reaches customers in more than 85 countries. Moxa delivers lasting business value by empowering industries with reliable networks and sincere service. Information about Moxa's solutions is available at www.moxa.com.

Moxa Americas USA

Toll Free: 1-888-MOXA-USA
Tel: +1-714-528-6777
Fax: +1-714-528-6778
usa@moxa.com

Brazil

Tel: +55-11-95261-6545
brazil@moxa.com

Moxa Europe

Tel: +49-89-413-25-73-0
europe@moxa.com

Moxa Asia-Pacific and Taiwan Asia/Taiwan

Tel: +886-2-8919-1230
Fax: +886-2-8522-8623
asia@moxa.com
taiwan@moxa.com

India

Tel: +91-80-4172-9088
Fax: +91-80-4132-1045
india@moxa.com

Korea

Tel: +82-2-6268-4048
Fax: +82-2-6268-4044
korea@moxa.com

Japan

Tel: +81-3-6721-5670
Fax: +81-3-6721-5671
japan@moxa.com

Moxa China Shanghai

Tel: +86-21-5258-9955
Fax: +86-21-5258-5505
china@moxa.com

Beijing

Tel: +86-10-5976-6123/24/25/26
Fax: +86-10-5976-6122
china@moxa.com

Shenzhen

Tel: +86-755-8368-4084/94
Fax: +86-755-8368-4148
china@moxa.com

Enabling Connectivity for Industrial Transformation



Industrial
Network Infrastructure



Industrial
Edge Connectivity



Industrial
Computing

Enabling Connectivity for Industrial Transformation

Network agility is key to create and hold a leading edge in industrial automation when starting your digital transformation journey. Moxa, a pioneer in industrial communication, provides a one-stop product portfolio comprising edge connectivity, industrial computing, and network infrastructure to enable your success in digital transformation. Moxa's one-stop solutions address the evolving connectivity needs between legacy and modern, IT and OT systems to optimize data collection and collaboration from the field to the cloud, overcoming difficulties in harsh operating environments.

We thank every customer and partner who has inspired our continuous innovations over the past 35 years. The Moxa team has learned to absorb complexity and translate all requirements into industry-proven reliability, security, and management. We design all our solutions for ease-of-use and easy integration to help boost your operational insights.

We are not alone in this digital journey. We have taken part and shared our experiences with global partners, industry initiatives, industry associations, and working groups, including IIC, IEEE, OPC foundation, CLPA, IEC and more. All the ecosystems are committed to build consolidated platforms and open standards for a digital and smart future.

Product Portfolio at a Glance



Industrial Network Infrastructure

Page 5-10

- Ethernet Switches
- Wireless AP/Bridge/Client
- Cellular Gateways/Routers
- Ethernet Media Converters
- Secure Routers
- Network Management Software



Industrial Edge Connectivity

Page 11-16

- Serial Device Servers
- Serial Converters
- Protocol Gateways
- USB-to-serial Converters/USB Hubs
- Multiport Serial Boards
- Controllers & I/Os



Industrial Computing

Page 17-18

- x86 Computers
- Arm-based Computers
- IIoT Gateways
- Panel Computers & Displays

Your Trusted Partner in Automation

Why Moxa



Long-term Commitment

We are committed to delivering the best value and success to our customers and partners worldwide through our industrial solutions and deeper collaboration.



Reliability Excellence

Strengthened by the pillars of device durability, always-on availability, and network security, we enable maximum uptime and optimal connectivity for mission-critical network applications.



Certified Device Security

Complying to the IEC 62443 standards, many Moxa products employ a secure-by-design approach throughout their development phase and lifespan to safeguard their use in industrial control and automation systems.



Cost-efficiency Enablement

Moxa fosters network efficiency through a variety of product features, including:

- Compact form-factor
- Ease-of-use tools and APIs
- Self-healing redundancy
- Turbo Chain for uninterrupted and unlimited subnet expansion
- Real-time network visibility
- Network interoperability
- Flexible scalability
- Certified reliability and security



Technology Advancement

Moxa demonstrates advances with industrial 5G, TSN, and seamless network redundancy to shape the future of automation networks.

- Industrial 5G
- Ready-to-connect TSN solutions
- PRP/HSR zero-time redundancy
- Millisecond-level wired and wireless redundancy



Vertical Industry Expertise

Moxa provides industry-specific networking, connectivity, and computing solutions to achieve the extreme reliability required for mission-critical substation, rail, marine, mining, and oil and gas applications.



Best-in-class Support

With over 35 years of expertise, Moxa provides highly trained technical support teams for application consulting and troubleshooting, as well as support services for long-term driver and OS updates.

Optimizing Digital Connectivity

for Industrial Automation

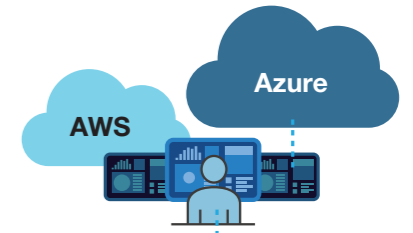
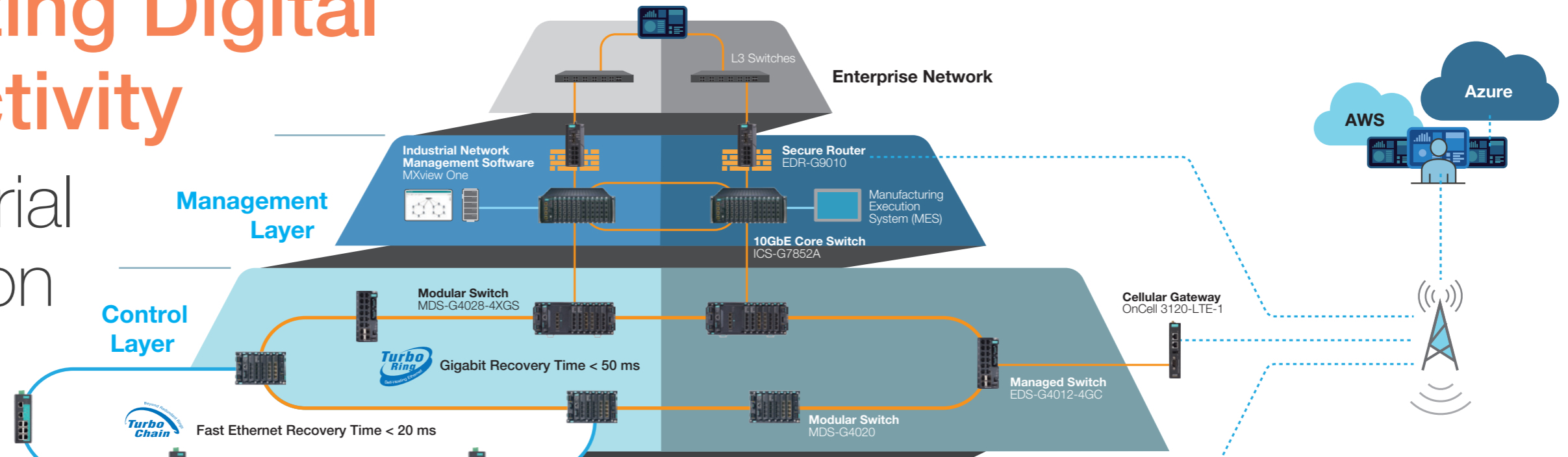

Application Scenarios

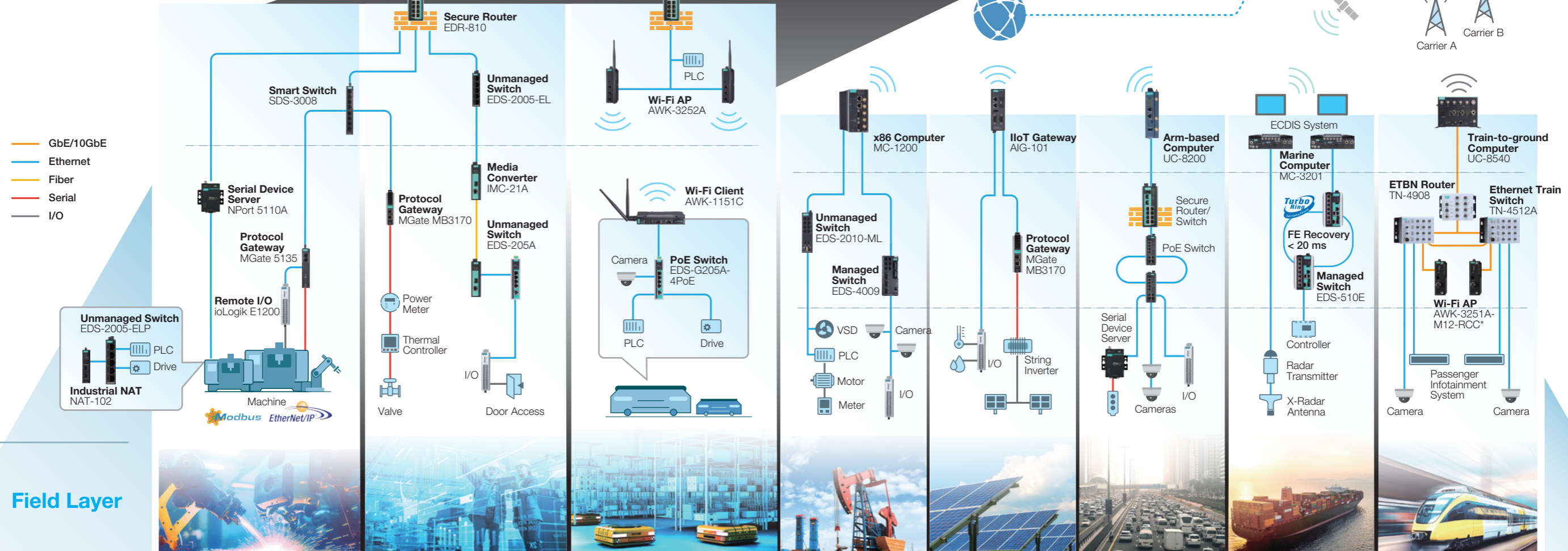

- GbE/10GbE
- Ethernet
- Fiber
- Serial
- I/O

Field Layer

Factory Automation

Oil & Gas

Power

ITS

Marine

Rail



* Available in Q3, 2023

Industrial Network Infrastructure

With over 35 years of industry experience, Moxa provides comprehensive industrial networking solutions that enable reliable communication and collaboration among systems, processes, and people for operational uptime and efficiency in harsh conditions.

- Unified networking and cybersecurity for defense-in-depth multi-layer network protection
- Rugged end-to-end connectivity for maximum uptime and operational continuity
- Enhanced visibility and management for faster response times



Layer 2 Managed Switches

Industrial networks need to keep up with increasing complexity, speed, and scale to manage resilient operations. Moxa provides a wide array of field-proven layer 2 managed switches that adapt to various application needs, such as adding new products to confined spaces, meeting power voltage requirements, and mitigating security threats.

- 5 to 52 ports, fixed and modular, 10G/2.5G/1G/100M models
- Flexible RJ45, SFP, and PoE options
- Supports fast network recovery under 20 ms/50 ms for Fast Ethernet and Gigabit Ethernet connections
- Security features based on the IEC 62443 standard
- Industry-proven reliability

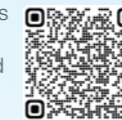

Best Seller

EDS-205A/208A Series 5/8-port Unmanaged Ethernet Switches

- FE and copper/fiber/PoE options
- Redundant power inputs
- -40 to 75°C operating temperature
- Diverse industrial certifications
- High MTBF values



Unmanaged Switches

Moxa's industrial unmanaged switches gain their global leadership with rock-solid reliability under extreme conditions, proven in thousands of long-term deployments worldwide. The lineup offers 5 to 18 port options in sizes as small as a credit card to facilitate cost-effective, install-and-forget Ethernet expansion.

- 5 to 18 ports FE/GbE copper, fiber, and PoE options
- QoS and BSP functions for traffic efficiency
- Redundant power inputs
- -40 to 75°C operating temperature
- Diverse industrial certifications



Smart Switches

The SDS-3000 Series smart switches simplify daily tasks for industrial automation (IA) engineers with easy configuration, quick installation, and field-site monitoring. Engineers can use either a web GUI or a rotary DIP switch to select IA protocols and enable SCADA/HMI integration for interoperable monitoring.

- 8/16-port switching functions tailor-made for OT applications
- Selectable IA protocols, including EtherNet/IP, PROFINET, and Modbus TCP
- One click to enable SCADA/HMI/NMS integration
- Supports RSTP/STP/MRP network redundancy
- Flexible mounting and extra-slim design



Layer 3 Managed Switches

If your core network is not insulated against harsh conditions, such as extreme temperatures, power surges, EMI, or link failures, you will be better off choosing Moxa's industrial layer 3 switches that interconnect your LANs with robust durability, millisecond-fast redundancy, and enhanced security to protect your data aggregation 24/7.

- Layer 3 routing for multi-LAN interconnection
- 12 to 52 ports, fixed and modular, rich 10GbE/GbE/FE models with media options
- Supports Turbo Ring and Turbo Chain for fast switching redundancy (20 ms for Fast Ethernet, 50 ms for Gigabit Ethernet)
- IEC 62443-4 compliant security features
- Supports -40 to 75°C operating temperature



Best Value

EDS-408A Series 8-port Managed Ethernet Switches

- Rich copper/fiber media options
- Millisecond-level failover recovery
- PROFINET or EtherNet/IP enabled by default
- Supports unlimited subchain expansion without network interruptions
- Diverse industrial certifications





Industrial Network Infrastructure



Entry-level

IMC-21A Series Industrial 10/100BaseT(X)-to-100BaseFX Media Converters

- Multi-mode or single-mode, with SC or ST fiber connector
- Link fault pass-through (LFPT)
- Superior EMI immunity
- -40 to 75°C operating temperature range (-T models)
- DIP switches to select FDX/HDX/10/100/Auto/Force

PoE/PoE+ Ethernet Switches

To simplify surveillance network deployment and maintenance, Moxa's PoE/PoE+ Ethernet switches offer high power, Gigabit speed, and SmartPoE management to remotely check, configure, and reboot PoE devices, reducing the need for on-site visits. Built-in reliability, security, and millisecond-fast recovery help keep your networks up and running.

- Wide selection of unmanaged and managed switches, up to 48 Gigabit PoE+ links
- Supports IEEE 802.3af/at/bt PoE output options
- SmartPoE for easy PoE linking, diagnosis, and monitoring
- Up to 4 kV LAN surge protection
- -40 to 75°C operating temperature



Ethernet Media Converters

Moxa's industrial media converters provide copper-to-fiber, Gigabit speed extensions of up to 120 km over single-mode fiber in harsh conditions. Compact models, such as the IMC-101G and IMC-21GA fiber converters, are popular for machine vision inspection and outdoor surveillance that require Gigabit throughput and EMI immunity with fewer hops, regardless of the distance.

- Link fault pass-through to easily trace link status
- Alarms for power and link failure
- Redundant power inputs
- Diverse industry certifications
- -40 to 75°C operating temperature



EN 50155 Ethernet Switches

As an IRIS-certified manufacturer, Moxa provides a full-range Ethernet portfolio that has been deployed in many rail and metro systems around the world. Complying with the relevant parts of IEC 61375, EN 50155, and EN 50121-4 standards, our railway-rugged solutions help improve transport safety and the efficiency of railway operation and maintenance.

- Full-GbE train backbone with layer 3 routers and layer 2 switches
- Onboard broadband Wi-Fi access
- Seamless train-to-ground via Wi-Fi and cellular connectivity
- A wide range of port combination for different rail networks
- EN 50155 proven reliability from trains to tracks



IEC 61850-3 Ethernet Switches

Moxa's PowerTrans Series is a family of IEC 61850-3 and IEEE 1613 certified Ethernet switches that can withstand harsh EMC to provide communication between IEDs (intelligent electronic devices) with no packet loss or message errors. PowerTrans switches also support the IEEE 1588v2 standard to coordinate network devices with nanosecond-precise time synchronization.

- IEC 61850/IEEE 1613 certified (KEMA tested)
- EMC-immunity technology for zero packet loss
- Nanosecond-precise time synchronization (IEEE 1588v2)
- Supports PRP/HSR and Turbo Ring/Turbo Chain self-healing redundancy
- -40 to 85°C operating temperature



Industrial Network Infrastructure



All-in-one

EDR-810 Series 8 FE Copper + 2 GbE SFP Industrial Secure Routers

- 8+2G all-in-one firewall/NAT/VPN/router/switch
- IPsec VPN for secure remote access tunnel
- Configurable WAN/LAN for router firewall and transparent firewall
- Modbus TCP deep packet inspection
- Supports RSTP/Turbo Ring for network redundancy

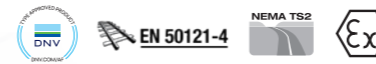

Certified Security

AWK-1151C Series Industrial IEEE 802.11a/b/g/n/ac Wireless Client

- IEC 62443-4-2 SL2 certified security
- High EMC for wireless reliability
- Millisecond-level client-based Turbo Roaming
- UN model support configurable multiregional RF compliance
- -40 to 75°C operating temperature

E1



Wireless AP/Bridge/Client

Moxa's industrial wireless products offer field-proven AP/bridge/client connectivity and innovative software features to protect wireless connectivity from interference and downtime caused by extreme operating temperatures, ESD, EMI, surges, or shock and vibration. Users can gain wireless visibility through our MXview Wireless management suite.

- IEEE 802.11a/b/g/n/ac wireless AP/bridge/clients
- Industrial hardened EMC and antenna protection
- Supports Turbo Roaming for sub 150 ms handovers
- Supports MXview Wireless for dynamic Wi-Fi visibility
- Built-in security based on IEC 62443 standards



Cellular Gateways/Routers

Moxa's industrial cellular solutions are designed for WWAN (Wireless Wide Area Network) communications with serial and Ethernet devices over cellular networks. With the growing demand for increased bandwidth over cellular connections, Moxa's WWAN solutions have expanded to 4G LTE, enabling cellular devices to deliver live video streams anywhere, anytime.

- Supports serial/Ethernet-to-cellular connections
- IPsec, GRE, and OpenVPN for secure connections
- Always-on reliability with dual-SIM and GuaranLink features
- WAN failover between cellular and Ethernet
- ATEX, IECEx, and C1D2 certified for use in hazardous locations



Secure Routers

Moxa offers industrial secure routers that provide firewall/NAT/VPN/router/switch all-in-one functions and OT-centric data filtering to protect critical assets and ensure secure remote access. Additionally, Moxa offers IEC 61375-2-5 Ethernet routers that can handle traffic between Ethernet train backbones and Ethernet consist networks.

- Firewall/NAT/VPN/router/switch all-in-one functions
- Industrial-grade Intrusion Prevention/Detection System (IPS/IDS)
- Deep packet inspection for OT traffic filtering
- Built-in security based on IEC 62443/NERC CIP
- IEC 61375-2-5 Ethernet secure routers for train backbone and consist networks



Network Management Software

Moxa provides the MXstudio suite and MXview One automation-friendly network management platform to help OT engineers gain real-time network visibility to simplify management of converged IT/OT networks, enable faster responses and optimize network uptime.

- Mass configuration to save time and reduce errors
- Live-view topology monitoring and alerting
- A dashboard view with a network summary
- Single-pane-of-glass management that enables integrated monitoring across various systems
- Management add-ons tailored for substation and wireless network monitoring



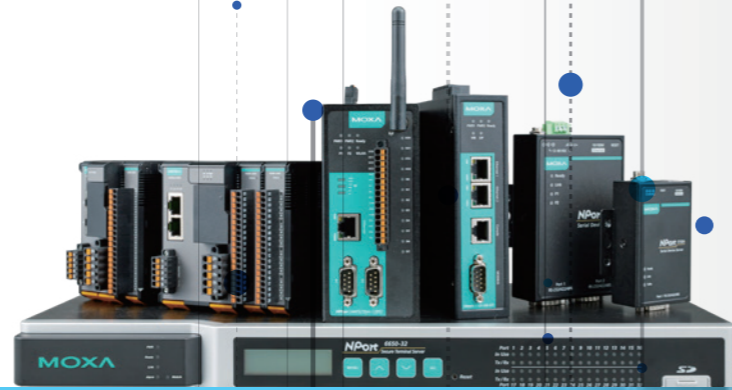

Industrial Edge Connectivity

As an industry leader with a portfolio of over 500 serial/fieldbus/USB connectivity products, Moxa has been providing reliable industrial solutions for field connectivity across legacy and modern systems since 1987. Our edge device connectivity solutions feature proven reliability, security, industrial protocols and smart software that make your digital transformation fast and easy.

- Industrial reliability for long-lasting operations
- Enhanced security based on IEC 62443 standards
- A wide variety communication interfaces and protocols supported

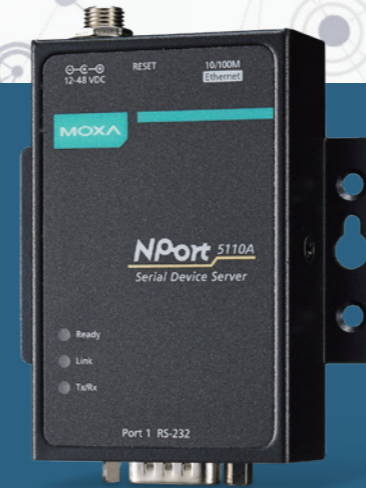

NPort 5100A Series 1-port RS-232/422/485 Serial Device Servers

- Power consumption of only 1 W
- Fast 3-step web-based configuration
- Surge protection for serial, Ethernet, and power
- Real COM and TTY drivers for Windows, Linux, and macOS
- Connects up to 8 TCP hosts

Serial Device Servers

General Device Servers

Our NPort device servers make your serial devices network-ready in an instant. Their compact size makes them ideal for connecting devices such as card readers and payment terminals to an IP-based Ethernet LAN.

- 1 to 16 port serial-to-Ethernet converters
- Surge protection for serial, Ethernet, and power (selected models only)
- Real COM and TTY drivers for Windows, Linux, and macOS



Combo Device Servers

Moxa's integrated serial device server solutions merge a wealth of features into an all-in-one design that combines a managed Ethernet switch and a device server into a single device. The design satisfies multiple project requirements in a fraction of the space needed for separate devices, simplifying device configuration and reducing operational and maintenance costs.

- 1 to 16 port serial-to-Ethernet solutions with additional Ethernet switch features
- Class I Div. 2 certified reliability (selected models)
- -40 to 75°C operating temperature (T-model)



Wireless Device Servers

Our wireless device servers are the ideal choice for connecting your serial or Ethernet devices—such as PLCs, meters, and sensors—to a wireless network, avoiding the hassle of running a network cable to each device.

- 1 to 2 port serial-to-Wi-Fi device servers
- Secure data access with WEP, WPA, WPA2
- Offline port buffering and serial data log



Industrial Device Servers

Our industrial device servers offer enhanced surge protection and have certifications for hazardous locations, including rolling stock and wayside. In addition, all the devices are designed to ensure reliable serial-to-Ethernet connectivity when operating in harsh environments, such as oil and gas and power automation.

- 1 to 4 ports serial-to-Ethernet device servers
- Cascading Ethernet ports for easy wiring
- Enhanced surge protection for serial, LAN, and power



Terminal Servers

Moxa's terminal servers are equipped with the specialized functions and security features needed to establish reliable terminal connections to a network. They can connect various devices such as terminals, modems, data switches, mainframe computers, and POS devices to make them available to network hosts and processes.

- 1 to 32 port device converters for encrypted serial data over Ethernet
- Dual LAN and dual power redundancy (selected models)
- Security features based on IEC 62443



Serial Embedded Modules

Moxa's embedded serial-to-Ethernet device server modules are compact, power-efficient, and easy to integrate.

- 32-bit Arm Core with 4 configurable DIO channels
- Supertiny embedded device servers with low power consumption
- Supports NetEZ to make integration incredibly easy



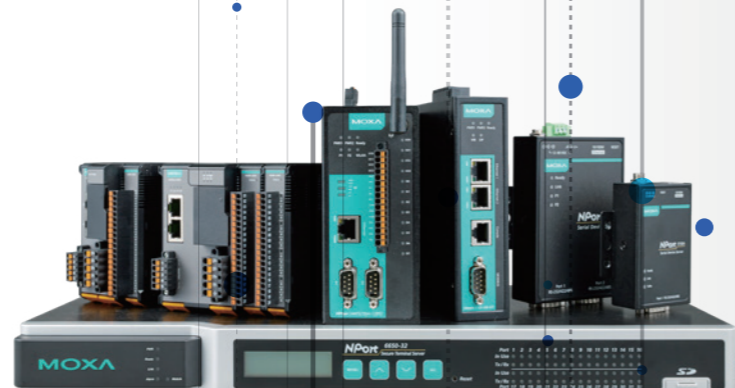

Industrial Edge Connectivity



Industrial Protocol Gateways

Modbus TCP Gateways



Whether single or multiple serial ports, Moxa's Modbus TCP gateway solutions convert data in networks between Modbus RTU/ASCII, Modbus TCP, DNP3, CANopen, J1939, PROFIBUS, BACnet/IP, IEC 101/104, and IEC 61850, making configuration, troubleshooting, and conversion quick and easy.

- Easy device configuration via web-based console
- Embedded traffic monitoring/diagnostic information for easy troubleshooting
- Built-in Ethernet cascading for easy wiring
- Serial port with 2kV isolation protection, redundant power inputs, and -40 to 75°C wide operating temperature
- Developed according to IEC 62443-4-2

PROFINET Gateways



Effortlessly connect fieldbus devices to a PROFINET network with our MGate industrial PROFINET gateway solutions.

EtherNet/IP Gateways



Moxa's Ethernet/IP gateways enable various communication protocol conversions in an EtherNet/IP network.

Fieldbus Gateways



Connecting industrial serial devices in a plant can be quick, easy, and reliable with our fieldbus gateway solutions. Their smart functionality makes connecting your Modbus and PROFIBUS devices effortless.

- Simplify PROFIBUS system integration via easy web-based console configuration
- Embedded traffic monitoring/diagnostic information for easy troubleshooting
- Serial port with 2kV isolation protection, redundant power inputs, and -40 to 75°C wide operating temperature



MGate 5135/5435 Series 1 and 4-port Modbus RTU/ASCII/TCP-to-EtherNet/IP Gateways

- Flexible deployment with Ethernet cascading and dual subnet
- Embedded traffic monitoring/diagnostic information for easy troubleshooting
- Easy device configuration via a web-based console
- Larger input/output data size
- Developed according to IEC 62443-4-2 with Secure Boot



MGate MB3170/MB3270 Series 1 and 2-port Serial-to-Ethernet Modbus Gateways

- Intuitive configuration tools by web or utility
- Traffic monitoring tools to simplify Modbus troubleshooting
- Serial port isolation (-I models) and fiber models (fiber models)
- Flexible and granular Modbus related settings such as interval timeout, serial redirector, auto Modbus routing, and priority control
- Built-in Ethernet cascade for easy wiring

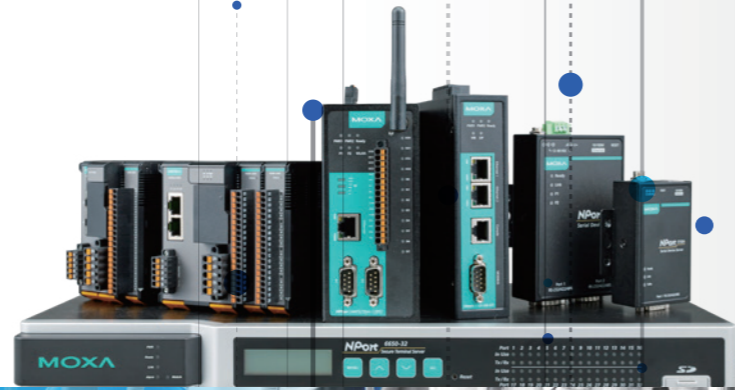

Industrial Edge Connectivity

Diverse Field Connectivity

Serial Converters

Moxa's serial media converters allow devices with different serial interfaces to communicate effortlessly. Serial-to-serial converters help convert between RS-232 and RS-422/485, and serial-to-fiber converters convert all three interfaces to optical fiber.

- > Serial-to-serial Converters
- > Serial-to-fiber Converters
- > Fieldbus-to-fiber Converters

- Supports media conversion between serial, fiber optic, fieldbus, and CAN
- Single-mode fiber transmission up to 40 km
- High EMI immunity
- LED indicators for status monitoring
- Wide operating temperature ranges



USB-to-serial Converters/ USB Hubs

Moxa's UPort series of USB-to-serial converters provides Hi-Speed USB 2.0 speeds up to 480 Mbps, and our USB hubs provide Super-Speed USB 3.0 speeds up to 5 Gbps. Both come with 15 kV of ESD protection and metal housing to endure harsh environments, making them ideal for ATMs, kiosks, POS stations, and data-acquisition applications.

- > USB-to-serial Converters
- > Industrial-grade USB Hubs

- 1 to 16 port USB-to-serial cards converters
- 4 and 7-port USB 3.2 hubs up to 5 Gbps data rates
- USB-to-serial converters support LEDs for easy monitoring
- Enhanced EMI immunity
- Wide operating temperature ranges



Multiport Serial Boards

With over 35 years of experience in multiport serial board technology and development, Moxa offers one of the most comprehensive selections of industrial-grade multiport serial cards on the market. We offer serial boards for a variety of slot types, from PCI Express to CANbus and PC/104.

- PCIe/UPCI/PCI serial cards
- CANbus serial boards
- PC/104 serial boards
- Industrial reliability with ESD surge protection
- Long-term driver support



Controllers & I/Os

Moxa provides a wide range of controllers and I/O products for industrial automation applications. Built with push technology, our I/O devices accelerate I/O responses while still ensuring accurate data collection. Moxa's Click&Go Plus simplifies configuring control logic rules, and provides support for multiple OT/IT protocols, which makes it easier for you to realize your IIoT application. Our products have been successfully deployed in factories, energy and transportation applications, and city infrastructure.

- Advanced controllers and I/Os for modular scalability and cloud connectivity
- Universal controllers and I/Os for smart data collection with Click&Go Plus control logic
- Rugged controllers & I/Os for programmable controls in critical industry applications



UPort 200A Series 4 and 7-port General-purpose USB 3.2 Hubs

- USB-IF certification
- USB 3.2 SuperSpeed allows true speeds up to 5Gbps
- ESD Level 4 Protection
- DIN-rail housing and wall-mountable housing
- 5-year warranty



ioLogik E1200 Series Ethernet Remote I/O With 2-port Ethernet Switches

- User-definable Modbus TCP Slave addressing
- Supports RESTful API, SNMPv1/v2c for IIoT applications
- Supports EtherNet/IP adapter
- Saves time and wiring costs with peer-to-peer communications
- 2-port Ethernet switch for daisy-chain topologies



Industrial Computing

Collaborating with industry partners around the world, Moxa's industrial computing solutions combine certified durability, hardware-based and software-based security, and long-term software support to simplify deployment, and also keep your mission-critical applications up and running in extreme conditions.

- Robust designs certified with industrial standards to fortify your mission-critical applications
- A trusted partnership with commitment to product longevity and long-term support
- Customer-centric service that helps customers build solutions to meet needs



Flexible Expansion



IIoT Ready



UC-2100 Series

Arm Cortex-A8 600 MHz Palm-sized Industrial Computers



- Rich interface options, including serial, GbE/FE, Wi-Fi and cellular connections
- Mini PCIe socket for Wi-Fi/cellular expansion (UC-2104)
- Moxa Industrial Linux platform with 10-year support
- Supports MXview for devices and computing status monitoring
- -40 to 75°C operating temperature

AIG-101 Series

2-port Modbus to MQTT/Azure/AWS IIoT Gateways

- Supports data conversion from Modbus TCP/ASCII/RTU to Azure, AWS, and MQTT cloud
- Built-in monitoring and diagnostic tools for easy troubleshooting
- Supports data logger functions to prevent data loss
- Supports Moxa ioLogik and UPort devices to extend I/O and serial interfaces
- Built-in data pre-processing with no coding needed

x86 Computers

Our industrial-grade, fanless x86 computers have passed rigorous tests and strictly adhere to rigorous industrial standards to ensure they can provide long-lasting, reliable operation even in harsh environments, making them perfect for heavy industry, power substation and utilities, transportation, oil and gas, and maritime applications.

- High-performance CPU processors
- Rich interfaces and expansion to meet specific needs
- Intelligent software and utilities
- Long-term software support
- Certified reliability for mission-critical applications



Arm-based Computers

Moxa's Arm-based computing family offers wireless-ready, compact, and fanless industrial computers built for space-constrained automation applications. These computers are specially designed for long-term operations and come with both a 5-year hardware warranty and 10-year support for Moxa's Industrial Linux, making them the ideal choice for remote monitoring and data acquisition applications.

- High-speed ARM processors
- Automatic failover between Wi-Fi, cellular, and Ethernet connections
- TPM 2.0 and software features for solid security
- Automatic system failover for system recovery and file backup
- 10-year long-term Moxa Industrial Linux (MIL) OS support



IIoT Gateways

To help our customers rapidly enter the IIoT world, Moxa provides secure, reliable, and easy-to-use IIoT solutions that can streamline sensor-to-cloud integration to transform data into actionable insights. Our IIoT gateways offer value-added features that reduce the burden on programming to drive digital transformation for IIoT systems.

- Secure Boot ensures effective protection against cyberattacks
- Reliable WLAN and WAN via built-in LTE and mPCIe Wi-Fi expansion
- Easily transfers Modbus data to Azure, AWS, and other MQTT-based cloud platforms
- Streamline device provisioning and maintenance with our device management tool
- Compact designs durable in extreme temperature



Panel Computers & Displays

Moxa's industrial-grade panel computers and displays are built to withstand the elements, and feature a ruggedized design that makes them ideal for HMI applications in outdoor, hazardous, and marine environments. Certifications include C1D2 and ATEX Zone 2, and marine standards such as DNV GL and CCS.

- Tailored to mission-critical applications
- Sunlight readable displays for outdoor applications
- Supports various PLCs and SCADA systems
- Fanless and IP66-rated waterproof design to sustain reliability
- Supports glove-friendly multitouch screen

